

BEKO

*installation & operating
instructions and washing guidance*

**Built-In Automatic
Washer Dryer Machine**

BWD 6421



get the **best** from your new washer

Read this manual prior to initial operation of the product!

Dear Customer,

We hope that your product, which has been manufactured in modern facilities and passed through a strict quality control procedure, will give you very good results. We advise you to read through this manual carefully before using your product and keep it for future reference.

The User Manual will help you use your machine in a fast and safe way.

- Read the User Manual before installing and starting your product.
- In particular, follow the instructions related to safety.
- Keep this User Manual within easy reach for future reference.
- Also read all additional documents supplied with this product.

Remember that this User Manual is also applicable for several other models. Differences between models will be identified in the manual.

Explanation of symbols

Throughout this User Manual the following symbols are used:

 Important information or useful hints about usage.

 Warning for hazardous situations with regard to life and property.

 Warning for supply voltage.

INFORMATION FOR THE CORRECT DISPOSAL OF WASTE ELECTRICAL AND ELECTRONIC APPLIANCES

When your appliance is of no further use, it should not be disposed of together with general domestic waste. It can be taken, free of charge, to a specific waste collection centre, run by your local authority, or dealers who provide this service.

Disposing of waste domestic appliances separately means avoiding possible negative consequences for the environment and health, derived from incorrect disposal. This will enable the materials in them to be treated and

recycled, obtaining important savings in energy and resources.

To highlight the obligation of collaborating with selective waste collection, the product is marked with a symbol to warn against using traditional containers for disposing of the appliance.



For further information, contact your local authority or the shop where you purchased the product.

TABLE OF CONTENTS

1 Your washing machine	4	6 Maintenance and cleaning	18
Overview	4	Maintenance	18
2 Warnings	5	Cleaning the detergent dispenser . . .	18
Intended use	5	Cleaning The Filter	19
3 Installation and assembly	6	Cleaning the outside	19
Unpacking the washing machine	6	7 Safety and troubleshooting	20
Unblocking the washing machine	6	8 Guarantee	22
Connection to the mains water supply	6	9 Service	23
Drainage connection	7		
Levelling	8		
Electrical connection	8		
Pre-cleaning	9		
4 Preparing to wash	10		
Preparing garments for washing	10		
Sorting the clothes	10		
Detergent and additives.	11		
eco-note	11		
5 Selection Of Washing And Drying Programme	12		
eco-note	12		
Spin speed selection	14		
Time delay selection	14		
Additional functions	15		
Starting up.	16		
Child/key lock function	16		
Wash/dry program status and power cuts.	17		
Power Cuts	17		

1 Your washing machine

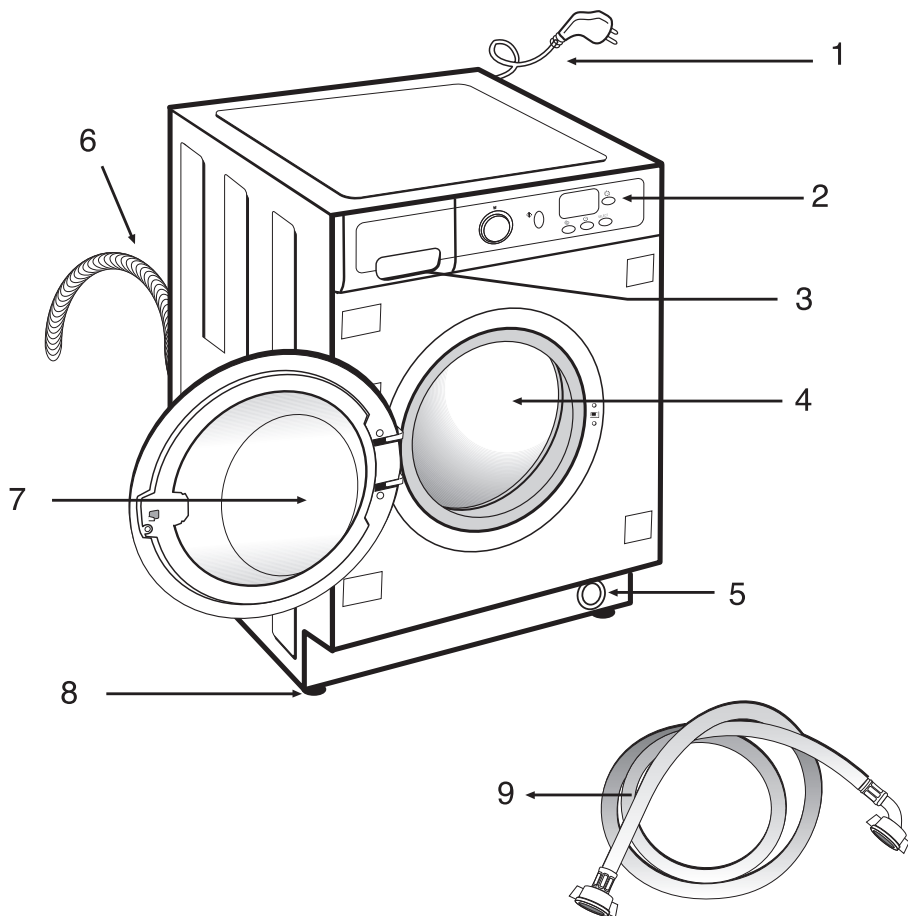

Overview

- 1- Power Cord
- 2- Control Panel
- 3- Detergent dispenser
- 4- Stainless steel drum
- 5- Accessible filter

- 6- Drain hose
- 7- Hatch
- 8- Adjustable feet
- 9- Water inlet hose

2 Warnings

To avoid the risk of fire, electric shocks, injury or damage when using your washing machine, please take the following precautions:

- This washing machine comes with a manual that includes operating, maintenance and installation instructions. Please read all the instructions before using the washing machine.
- Do not wash items that have previously been cleaned, washed, soaked or treated with petrol, solvents for dry cleaning, other inflammable substances or explosives, as they produce fumes that could catch fire or explode.
- Do not add petrol, solvents for dry cleaning or other inflammable or explosive substances to the wash water as they produce fumes that could catch fire or explode.
- Do not repair or replace any part of the washing machine or try to carry out any type of servicing unless it is recommended in the maintenance instructions in the manual.

- Do not climb onto the machine or stand on the open hatch door.
- Do not use an extension lead or adaptor to connect your washing machine to the mains supply.
- The machine should only be used for the purpose it is designed for.
- Follow the washing instructions recommended by the manufacturer of the garment to be washed.
- Do not turn your washing machine on until you are sure that:
 - It has been installed in accordance with the installation instructions.
 - All the water, drainage, mains electricity and earth connections meet the local regulations and/or other applicable regulations.

Intended use

- This appliance is not intended for use by persons (including children) with reduced physical, sensory or mental capabilities, or lack of experience and knowledge, unless they have been given supervision or instruction concerning use of the appliance by a person responsible for their safety.
Children should be supervised to ensure that they do not play with the appliance.

3 Installation and assembly

Unpacking the washing machine

- Remove the base, corner protectors and top cover.

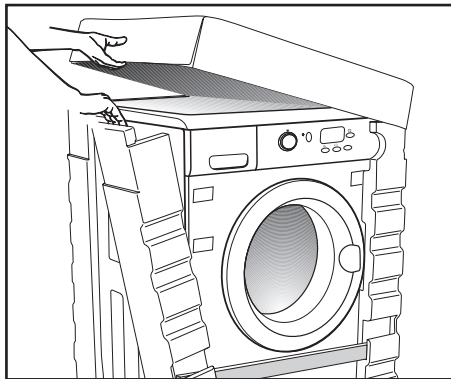

- Cover the holes with the plastic covers you have just removed.

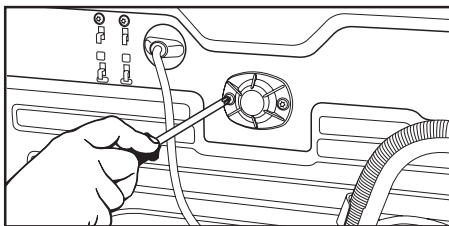

- i** Do not throw the blocking screws away. You may need to move the washing machine at a later date.

Connection to the mains water supply

The water supply hose is inside the drum:

Unblocking the washing machine

- Remove the screws holding the plastic covers to the back of the washing machine.

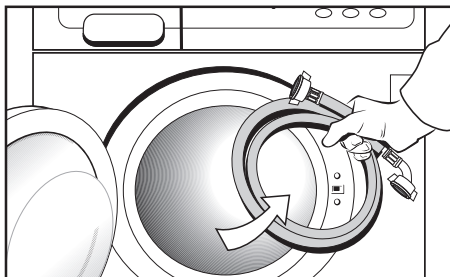
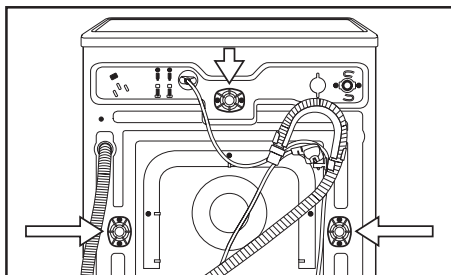

- Loosen and remove the 3 blocking screws.

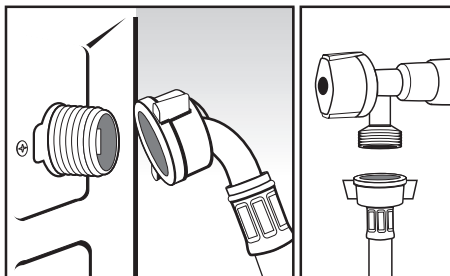
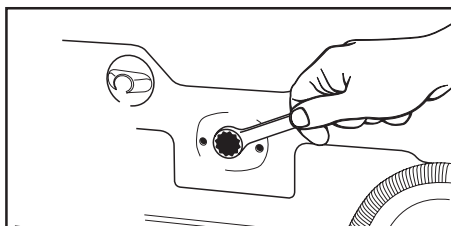

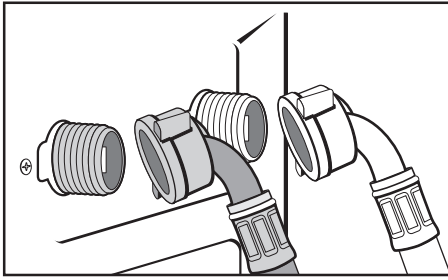

- Connect the other end of the hose to the water intake. Then securely tighten the connection nut.
- Make sure that the gasket is in place.
- i** It is important that the drain hose bend is correctly fastened to the outlet, to prevent any risk of it becoming detached and causing flooding.
- i** If your washing machine has a hot water intake, connect the hose with the red threaded end to the hot water tap, and to the electrovalve with the red filter.
- i** The washing machine must be connected to the mains water supply, using the new supply hoses supplied with the appliance. Do not use water supply hoses that have been used before. For your washing machine to work properly, the mains water pressure must be between 0.05 and 1MPa (0.05 and 10 Kgr/cm²).

Drainage connection

To make the washing machine ready for use, make sure that tap water supply and water drainage systems are appropriate before calling the authorised service agent. If they are not, call a qualified plumber to have any necessary arrangements carried out.

- It is recommended that you have a fixed drainage outlet 50 to 70 cm from the floor. Avoid the drain hose being too tight, kinked or restricted.
- The end of the drain hose must be directly connected to the wastewater drain or to the washbasin.
- The end of the drain hose must always be secured regardless of the connection type.
- !** Your floor will be flooded if the hose comes out of its housing during water discharge.
- In case the hose is routed at floor level or close to the floor (less than 50 cm) and then rises higher, water discharge becomes more difficult and laundry will come out wetter than normal. Therefore, follow the heights described in the figure.
- To prevent flow of dirty water back to the washing machine and to allow for easy discharge, the end of the hose must not be inserted in to the drain more than 15 cm. If it is too long, cut it shorter.
- The end of the hose should not be bent, it should not be stepped on and the hose must not be pinched between the drain and the machine.

- If the length of the hose is too short, add an original extension hose. The maximum length of the hose must not be longer than 3.2 m from the machine outlet. To avoid water leak failures, the connection between the extension hose and the drain hose of the product must be well fitted with an appropriate clamp so that it will not come off and leak.

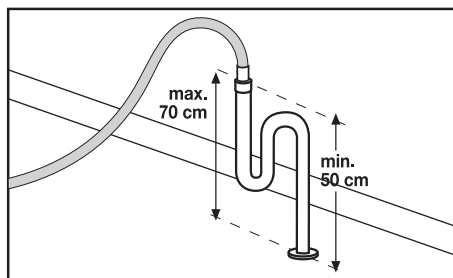

Levelling

- i** Use the adjustable feet to level the washing machine. This will reduce the noise level and prevent it from moving during use.
- i** Do not bring the feet too far out, you will achieve better stability.
- i** You need to use a spanner for the models that have a nut.

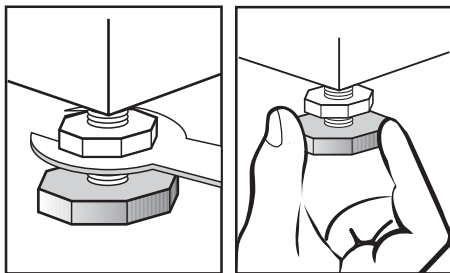
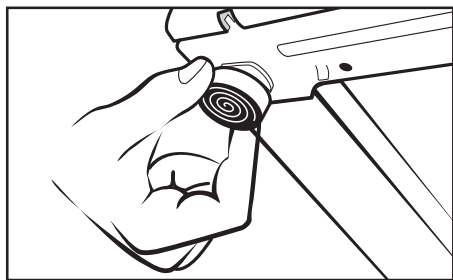

Electrical connection

Consult the specification plate located on the hatch door of the washing machine before making the electrical connections. Ensure that the voltage reaching the plug is the same as that on the plate.

Do not remove the specification plate. The information on it is important.

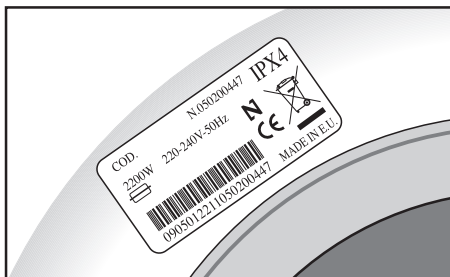

- i** It is very important to correctly earth the washing machine. The electrical installation, plug, socket, fuses or automatic switch and counter must be correctly specified for the maximum power indicated on the specifications plate.
- i** Do not plug the washing machine plug into the socket with wet or damp hands.
- i** To remove the power cord, pull on the body of the plug.

- i** If the power cord is damaged, it must be replaced by a cord or special unit provided by either the manufacturer or your after sales service.
- i** With built-in washing machines, the plug must be accessible after installation.

Pre-cleaning

When your washing machine has been correctly installed, we recommend that you pre-clean the machine.

This is to check that the installation, the connections and the drainage are all correct, and to thoroughly clean the inside of the washing machine before any wash programmes are run (see the operating instructions on the following pages).

- Select the normal programme at 60°C.
- Press the Start/Stop button.

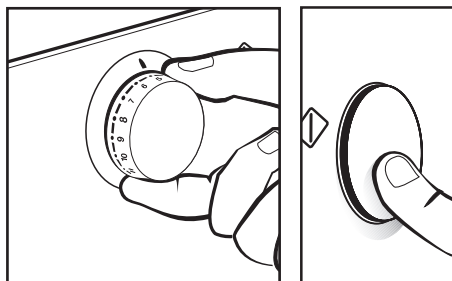

4 Preparing to wash

Preparing garments for washing

- i** Before placing the clothes in the drum, make sure all the pockets are empty.
- i** Any small objects may block the drain pump.

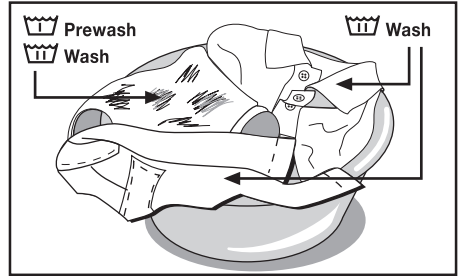
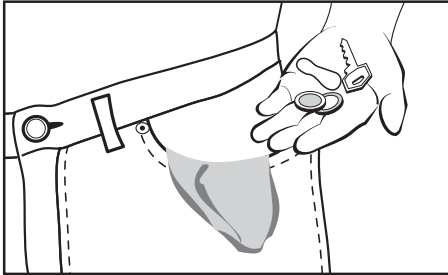

- **Sort your clothes according to colour.**

Wash whites and coloured separately.

Sorting the clothes

- **Sort the clothes according to fabric and how they are made:**



We recommend using the delicate programmes for sensitive fabrics. There is a special wool programme for woollens.

- i** Make sure beforehand that your woollens can be machine-washed.



Before using the drying programme, first check the label on the garment to make sure it can be tumble dried.

- **Sort clothes according to how soiled they are.**

Wash lightly soiled garments using a short programme.

Use a programme without prewash for medium-soiled garments.

Wash heavily soiled garments using a long programme with prewash.

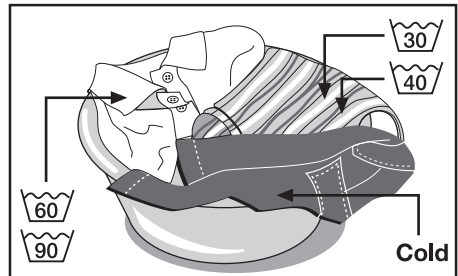

- i** We recommend loading the washing machine to its full capacity. This means savings on water and energy.
- i** Whenever possible, we recommend that you wash garments of different sizes within the same wash programme. This improves the washing action and also aids the correct distribution of the garments in the drum when spin-drying, and the washing machine will therefore be quieter.
- i** It is a good idea to put small garments in a wash bag.

Detergent and additives

- Your washing machine's detergent dispenser has three compartments.

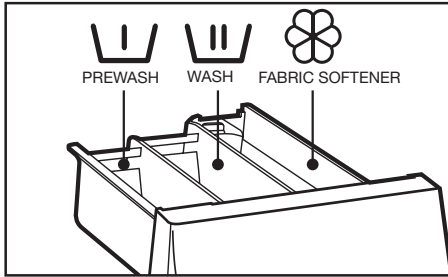

- Put the detergent or additive into the detergent dispenser before starting the wash programme.

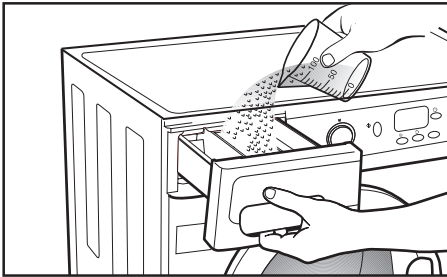

- Liquid detergents may also be used in this washing machine.

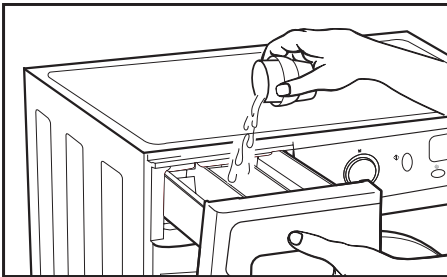

Place this optional dispenser inside the wash compartment.

- i** The level of liquid must never be higher than the MAX mark printed on the dispenser wall.

Remember that the amount of detergent to be used will always depend on:

- The amount of clothes to be washed.
 - How heavily the clothes are soiled.
 - The hardness of the water (Information on water hardness in your area can be obtained from the competent local authorities).
- i** We recommend the use of a decalcifying product if the water hardness is high in your area.

eco-note



Remember that concentrated detergents exist which are more environment and nature-friendly. The use of more detergent than necessary will not improve your washing results, and apart from costing you money it will have a negative effect on the preservation of the environment. We therefore recommend you follow the detergent manufacturer's instructions.

5 Selection Of Washing And Drying Programme

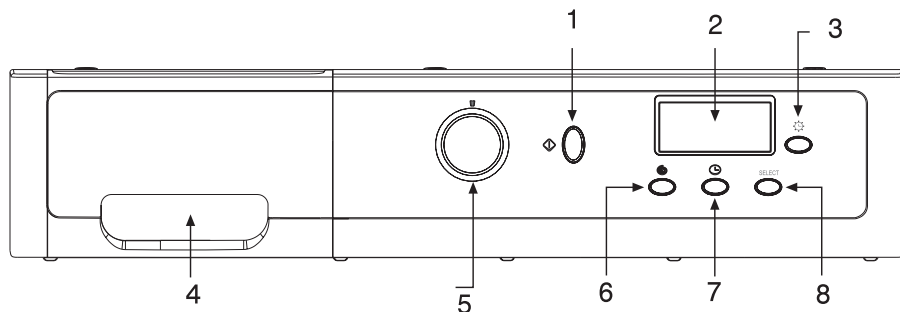

- | | |
|-----------------------|-------------------------------|
| 1 Start/stop button | 5 Programme selector command |
| 2 Screen | 6 Spin and anti-crease button |
| 3 Drying time button | 7 Time delay button |
| 4 Detergent dispenser | 8 Additional function button |

To select a wash programme, proceed as follows:

- Starting from the off "0" position, the washing machine turns on when selecting the desired wash programme, (see programme table).

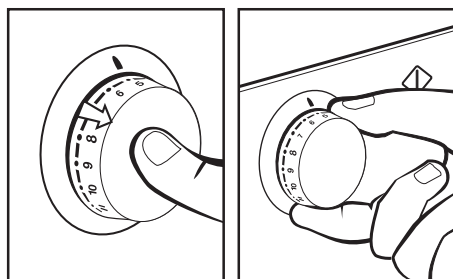

The procedure for selecting the drying time is as follows:

- Select drying time in minutes using the drying time button. The time will appear on the display, increasing each time the drying time button is pressed.

i If you select a wash + dry option, the load must not be over 4 kg. (1.5 kg. for delicate wash programmes).

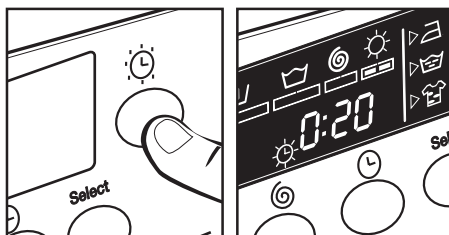

There are five types of programme:

- Normal programmes
- Auxiliary programmes
- Wool programmes
- Delicate programmes
- Drying programmes.

eco-note

 We recommend you choose a wash programme without prewash whenever possible. This will save you money and help protect the environment.

Possible option buttons										Approx. duration (minutes)
Programme	Recommended temperature	Fabric type	Extra rinse			Max load of clothes (Kg)	Wash product compartment	Programme description	Total consumption kWh/litres	
			Intensive wash	Easy-tron	Spin speed selection					Anti-crease
Normal programmes	1 Normal cold	Cold	Cotton/Linen delicate colours very light soil	YES	YES	6		Normal wash, rinses, automatic additive absorption if desired and long final spin	0.15/49	60
	2 Quick 30°C		Cotton/Linen whites/colours very light soil	YES	NO	1.5		SHORT wash, rinses, automatic additive absorption if desired and long final spin	0.20/30	30
	3 Normal 30°C		Cotton/Linen delicate colours light soil	YES	YES	6			0.40/49	82
	4 Normal 40°C		Cotton/Linen fast colours light soil	YES	YES	6		Normal wash, rinses, automatic additive absorption if desired and long final spin	0.65/49	87
	5 (*) Normal 60°C		Cotton/Linen fast colours medium soil	YES	YES	6			1.02/49	91
	6 Normal 90°C		Cotton/Linen whites heavy soil	YES	YES	6			1.90/55	110
Delicate programmes	7 Prewash 60°C		Cotton/Linen whites/fast colours heavy soil			6		Prewash, normal wash, rinses, automatic additive absorption if desired and long final spin	1.45/60	105
	8 Delicate cold	Cold	Synthetic/cotton mix delicate colours very light soil	YES	YES	3			0.15/55	50
	9 Delicate 30°C		Synthetic/cotton mix delicate colours light soil	YES	YES	3		Delicate wash, rinses, automatic additive absorption if desired and gentle final spin	0.35/55	50
	10 Delicate 40°C		Synthetic/cotton mix delicate colours medium soil	YES	YES	3			0.60/55	55
Wool P.	Wool 35°C	WOOL 35	Wool/wool mix whites/colours light soil	YES	NO	1		WOOL wash, rinses, automatic additive absorption if desired and gentle final spin	0.50/60	40
Auxiliary prog.	12 Rinses	-	Cotton/cotton mix Synthetic/Delicate Wool/wool mix	YES	NO	6		Rinses, automatic additive absorption if desired and long final spin	0.05/30	23
	13 Spin-drying	-	Cotton/cotton mix Synthetic/Delicate Wool/wool mix	NO	YES	6		Drain and long final spin	0.05/0	10
Drying prog.	14 Normal dry	-	Cotton/Linen	-	-	4		Normal dry	2.8/48	160
	15 Delicate dry	-	Synthetic/mixed fabrics	-	-	3		Delicate dry	1.8/27	100

(*) Programme for wash and energy consumption assessment in accordance with standard EN60456, press intensive wash button.

NOTE: the kWh and litre consumptions and programme durations may vary depending on the type and amount of clothes, mains water pressure, etc.

Spin speed selection

The wash options must always be selected after choosing the wash programme. Any programme change during selection cancels the previously selected options.

- **Spin speed selection and anti-crease button**

The selected programme has its own particular spin speed.

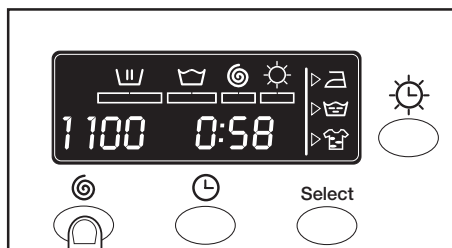

- You can change it by repeatedly pressing the spin button. The spin speed will gradually be reduced at 100 r.p.m. intervals to 400 r.p.m. for display models. On non-display models the LED will light up.

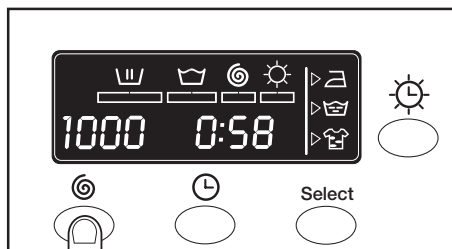

- **No spin 0**

Press the spin button again to get to the no spin option. A programme without a final spin. It is used to prevent creasing when washing special fabrics.

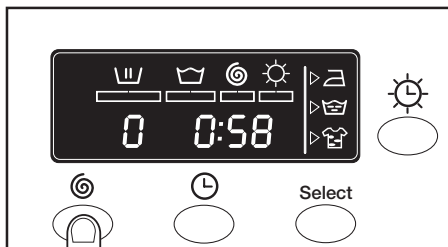

- **Anti-crease option 8**

The wash programme stops on the last rinse, with the clothes left in water. When the function is deactivated, the washing machine continues the programme, draining and spin-drying.

It is used, for example, when you are not at home and want to delay the spin-drying until you get home, to prevent the clothes creasing after spin-drying and being left in the drum to be removed.

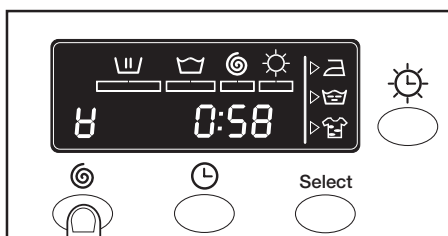

Time delay selection

Time delay selection button

A delay of up to **24 hours** can be selected.

The delay must be selected after choosing the wash programme.

To select the hours of delay, press the clock button. Each time the button is pressed the start of washing is delayed by 1 more hour.

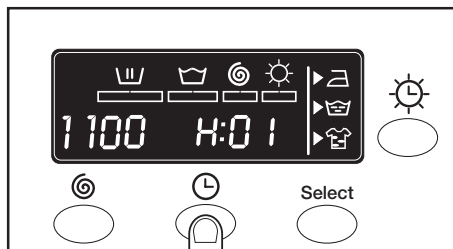

cancelling the delay

To cancel the delay you have to press the clock button successively. The delay will be cancelled when 24 hours have been reached and the button is pressed once more. If the programme is changed the delay is also cancelled.

Additional functions

Additional function selection button depending on programmes.

- There are 3 options: easy iron, extra rinse and intensive wash. Press the button and the desired option will be displayed.

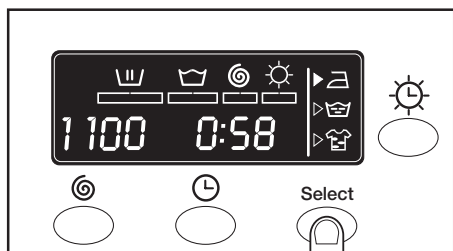

- By pressing the button several times you can choose between several **combinations** of one, two and up to three additional functions at the same time depending on the programme selected.

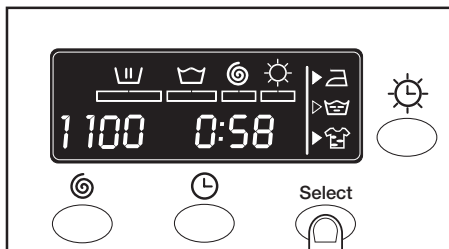

Easy-iron

This option prevents garments from creasing by means of carrying out a special programme with special turns to fluff out the garments after spin-drying and make them easier to iron.

Extra rinse

Increases the level of the final rinse obtained in the clothes; suitable for large loads and garments belonging to people with sensitive skin. Increases water consumption!

Intensive wash

This option, specially recommended for heavily soiled, stained clothes, achieves better results by extending the normal wash cycle.

- i** If during the additional function selection, the programme is changed or the ON/OFF button is pressed, all the functions selected until then are cancelled.

Starting up

Start/Stop button

- To start up the washing machine you have to press the **Start/Stop** button.
The minutes remaining until the end of washing and drying will appear on the display at all times.

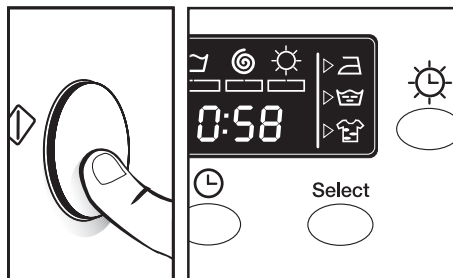

Child/key lock function

Child/key lock function selection

The lock function ensures that the programme will not be affected if any buttons are pressed. It is used when children could press the buttons, etc. The Child/Key Lock function should be activated after the wash programme has been selected together with all its options.

Activating the lock function

- The lock function is activated by pressing the Start/Stop button and holding it down for at least 3 seconds. The display will show if it is activated.

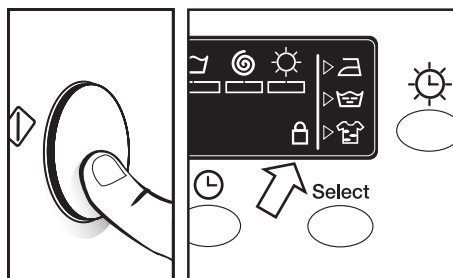

Deactivating the lock function

- The lock function is cancelled when the wash programme comes to an end.

If you want to deactivate the lock function before the end of the programme, you have to hold the Start/Stop button down again for at least 3 seconds. After 3 seconds, the lock function indicator will disappear from the display, and it will go into pause status. Turning to Off position "0" does not cancel the lock.

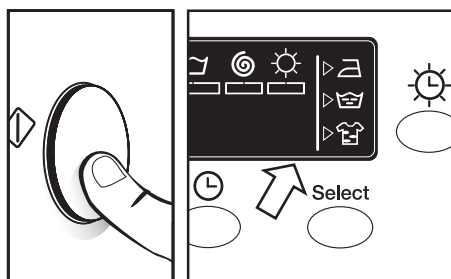

Wash/dry program status and power cuts

Programme Phases

Once started, current programme status and time remaining till completion can be ascertained from the screen.

The active phases will appear successively at the top of the display as the programme progresses. The time remaining until the end of the programme will also appear on the display. It updates at regular intervals, but not minute by minute.

Any option button can be selected provided the wash phase in which it takes effect has not been passed and when the programme accepts the option.

Pressing the start/stop button during the wash activates the PAUSE function.

i If the programme is changed on the selector dial during the washing and drying process, the washer-dryer will go onto PAUSE status and the programme will be cancelled.

i If you need to add or remove a garment, press the start/stop button and make sure that the water level is not above the door overflow level and that the temperature inside is not high. Press the start/stop button again to restart the wash from the same cycle phase it had stopped at.

Power Cuts

If there is a power cut, the washing machine will continue to operate from the point at which it stopped when power is reconnected (its memory lasts for a few hours).

Warnings:

- ⚠** Level the washing machine by adjusting the feet to reduce the noise caused by spin-drying.
- ⚠** Try and wash clothes of different sizes in the same wash programme to favour the distribution of the clothes inside the drum during spin-drying.
- ⚠** All the models have a safety system for spin-drying that prevents spin-drying from being carried out if the distribution of the clothes inside the drum is too concentrated. This prevents the appliance from vibrating too much. If you find that the clothes are not properly wrung out, try spin-drying them again after having distributed the clothes more evenly in the drum.



6 Maintenance and cleaning

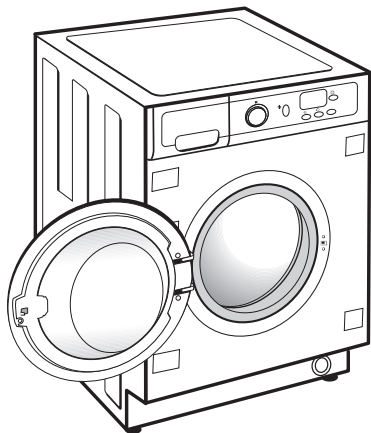

Maintenance

After each wash, leave the door open for a while to allow the air to circulate freely inside the machine.

From time to time, depending on the hardness of your water, it is recommendable to run a full wash cycle using a decalcifying product. **This will extend the life of your washing machine.**

- i** The washing machine should be disconnected from the mains electricity supply before any cleaning or maintenance is carried out.

Cleaning the detergent dispenser

Clean the detergent dispenser whenever there is any washing product residue left inside.

- Pull outwards on the detergent dispenser to remove it completely.

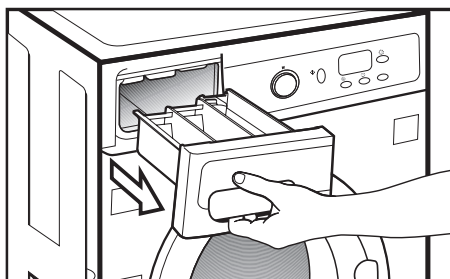

- Use warm water and a brush to clean the compartments.
- Also clean the additive compartment siphons, having removed them first. Once they have been cleaned, put them back making sure that they fit right in to the back. Put the dispenser back into the washing machine.

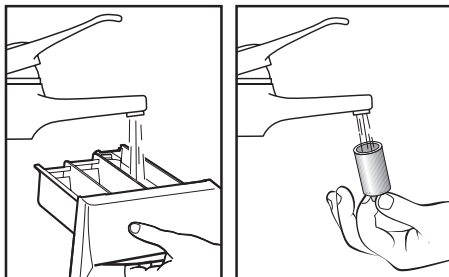

- i** A dirty or incorrectly fitted siphon will prevent the additives from being taken in and leave water inside the compartment at the end of the wash.

Cleaning The Filter

Clean the accessible filter if the drain pump is blocked by any foreign objects.

- Use a coin to turn the filter cap.
- Pull out the filter cap.

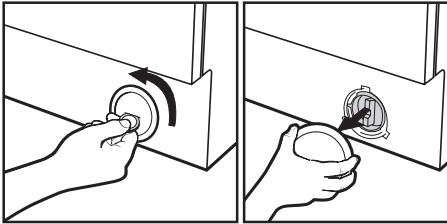

- Place a container under the drain pump filter to collect any water that comes out of it.
- Half- or quarter-turn the filter to the left.
Water will start to come out.

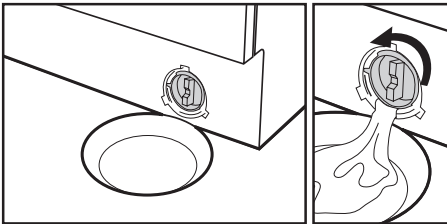

- When all the water has drained out of the washing machine, turn the filter several times until it can be completely removed by gently pulling on it.

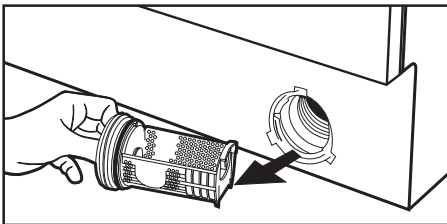

- Remove the objects or fluff caught in the filter or the drain pump. Put the filter and the filter cap back in place.

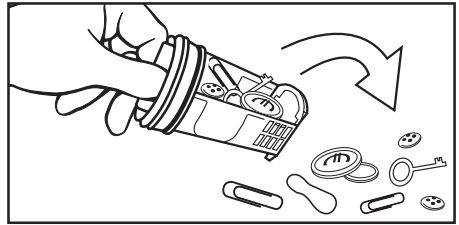

- i** To avoid burns, do not carry out this operation when the wash water is at a temperature of over 30°C.

Cleaning the outside

The outside of the washing machine should be cleaned with warm soapy water or a gentle cleaning agent. Do not use abrasive cleaning products or solvents.

It should then be thoroughly dried with a soft cloth.

- i** When there have been spillages of detergent or additives from the dispenser onto the washing machine cabinet, clean them up right away as they are corrosive.

7 Safety and troubleshooting

If you detect any problems with your washing machine, you will probably be able to rectify them yourself by consulting the following instructions. Important

If this is not the case, unplug the appliance and contact the **TECHNICAL ASSISTANCE SERVICE**.

i Never open up the appliance. There is no fuse or similar component inside that can be replaced by the user.

Indicator	Problems
FO1	No water coming in
FO2	Does not drain or spin-dry
CO3	Does not spin-dry
FO4	Does not start
FO5 . . F10	Call the Technical Assistance Service

Why won't the washing machine start?

- Check the door is properly shut.
- The washing machine is not plugged into the mains or there is no voltage in the mains supply.
- The Start/Stop button has not been pressed.
- If the washing machine door is not properly shut, **F04** will appear on the display.

Why is the washing machine vibrating or making too much noise?

- The blocking and transport screws have not been removed.
- The washing machine has not been correctly levelled.

Why doesn't the washing machine take in water?

- Indicator **F01**, no water coming in, this may be due to a cut in the water supply, a tap turned off or a blocked water inlet filter.
- The possible solutions are as follows: wait for the water supply to be reconnected, turn on the tap, or remove the water inlet hose and clean the filter.
If this failure is detected, **F01** will appear on the display.

Why doesn't the washing machine drain or spin-dry?

- The reasons for the **F02** indicator may be the following: washing machine drain pump blocked, building drainage pipes blocked, or incorrect pump electrical connection.
- Solution: if the pump is blocked, gain access to it as described in section 2, maintaining and cleaning the appliance.
If this failure is detected, **F02** will appear on the display.

Why doesn't the washing machine spin-dry?

- This may be due to an uneven distribution of clothes in the drum and may cause an excessive level of vibrations.
- The solution is to select a spin-drying programme.
If this failure is detected, **C03** will appear on the display

Why can't I see any water in the drum during the wash?

- This is due to the fact that the washing machine is provided with a system which is able to adapt to the load and type of fabrics, adjusting the levels of water and energy used, in order to preserve the environment.
So, although the water level you can see through the hatch may look low, there is no cause for concern as washing and rinsing efficiency will still be optimum.

Why is there still some water in the dispenser?

- This may be because the dispenser needs cleaning. This simple operation is described in **Maintaining and cleaning the appliance. - Cleaning the detergent dispenser.**

Why can't I open the hatch immediately after the wash has finished?

- Washing machines today are provided with safety systems for users. One of them is that the washing machine cannot be opened until it is certain that the drum is quite still. This is why the hatch cannot be opened for 2 minutes.

Why doesn't the remaining time shown on the clock coincide with the real time left until the selected cycle finishes?

- This time is for guidance purposes only and may be affected by the conditions under which the selected programme is being run, e.g. initial water temperature, size of load or unbalance caused by the garments during spin drying.

Other indications

- The washing machine can detect other indications. When this happens a number of other indicators appear on the display: **F05, F06..., F10**. If this happens, call the Official Technical Service.

8 Guarantee

Your new product is guaranteed against the cost of breakdown repairs for twelve months from the date of the original purchase.

What is covered?

- Repairs necessary as a result of faulty materials, defective components or manufacturing defect.
- The cost of functional replacement parts, but excluding consumable items.
- The labour costs of a Beko approved repairer to carry out the repair.

What is not covered?

- Transit, delivery or accidental damage or misuse and abuse.
- Cabinet or appearance parts, including knobs, flaps, handles or container lids.
- Accessories or consumable items including but not limited to, ice trays, scrapers, cutlery baskets, filters and light bulbs.
- Repairs required as a result of unauthorised repair or inexperienced installation that fails to meet the requirements contained in the user instruction book.
- Repairs to products used on commercial or non-residential household premises.
- Loss of frozen food in freezers or fridge/freezers. (Food loss insurance is often included within your household contents insurance policy, or may be available separately from your retailer).

Important notes.

- Your product is designed and built for domestic household use only.

- The guarantee will be void if the product is installed in a commercial or non-residential domestic household premises.
- The product must be correctly installed, located and operated in accordance with the instructions contained in the User Instructions Booklet provided.
- Professional installation by a qualified Electrical Domestic Appliance Installer is recommended for all Washing Machines, Dishwashers and Electric Cookers
- Gas Cookers must only be installed by a CORGI (or BORD GAIS) registered Gas Installer.
- The guarantee is given only within the boundaries of the United Kingdom and the Republic of Ireland.
- The guarantee is applicable only to new products and is not transferable if the product is resold.
- Beko disclaims any liability for incidental or consequential damages.
- The guarantee does not in anyway diminish your statutory or legal rights.

Should you experience any difficulty in obtaining service please contact the Customer Help-Line.

Tel: 0845 600 4911

e-mail: service@beko.co.uk

9 Service

Please keep your purchase receipt or other proof of purchase in a safe place; you will need to have it should the product require attention under guarantee.

You should also complete the details below; it will help us assist you when requesting service. (The model number is printed on the Instruction Booklet and the serial number is printed on the Rating Label affixed to the appliance)

Model No:

Serial No:

Retailer:

Date of purchase:

For service under guarantee simply telephone the appropriate number below

UK Mainland & Northern Ireland

Fridges & Freezers 0845 600 4903

Electric Cookers 0845 600 4902

Gas & 0845 600 4905

Dual Fuel Cookers

Washing Machines & 0845 600 4906

Dishwashers

Republic of Ireland

All Refrigeration, 01 862 3411

All Cookers

Washing Machines & Dishwashers

Before requesting service please check the trouble-shooting guide in the Operating Instructions as a charge may be levied where no fault is found even though your product may still be under guarantee.

Service once the manufacturers guarantee has expired.

If you have purchased an extended guarantee please refer to the instructions contained within the extended guarantee agreement document. Otherwise please call the appropriate number above where service can be obtained at a charge.

Should you experience any difficulty in obtaining service please contact the Customer Help-Line.

Tel: 0845 600 4911

e-mail:service@beko.co.uk

BEKO



**Beko plc. Beko House, Caxton Way, Watford
Hertfordshire, WD18 8UF**

Tel: 0845 6004911

Fax: 0845 6004922

Email: service@beko.co.uk

www.beko.co.uk